

**Zittau - Kurort Oybin**  
- Schmalspurbahn 750 mm -

gültig vom 22.05.1932 bis 01.10.1932  
12,23 km

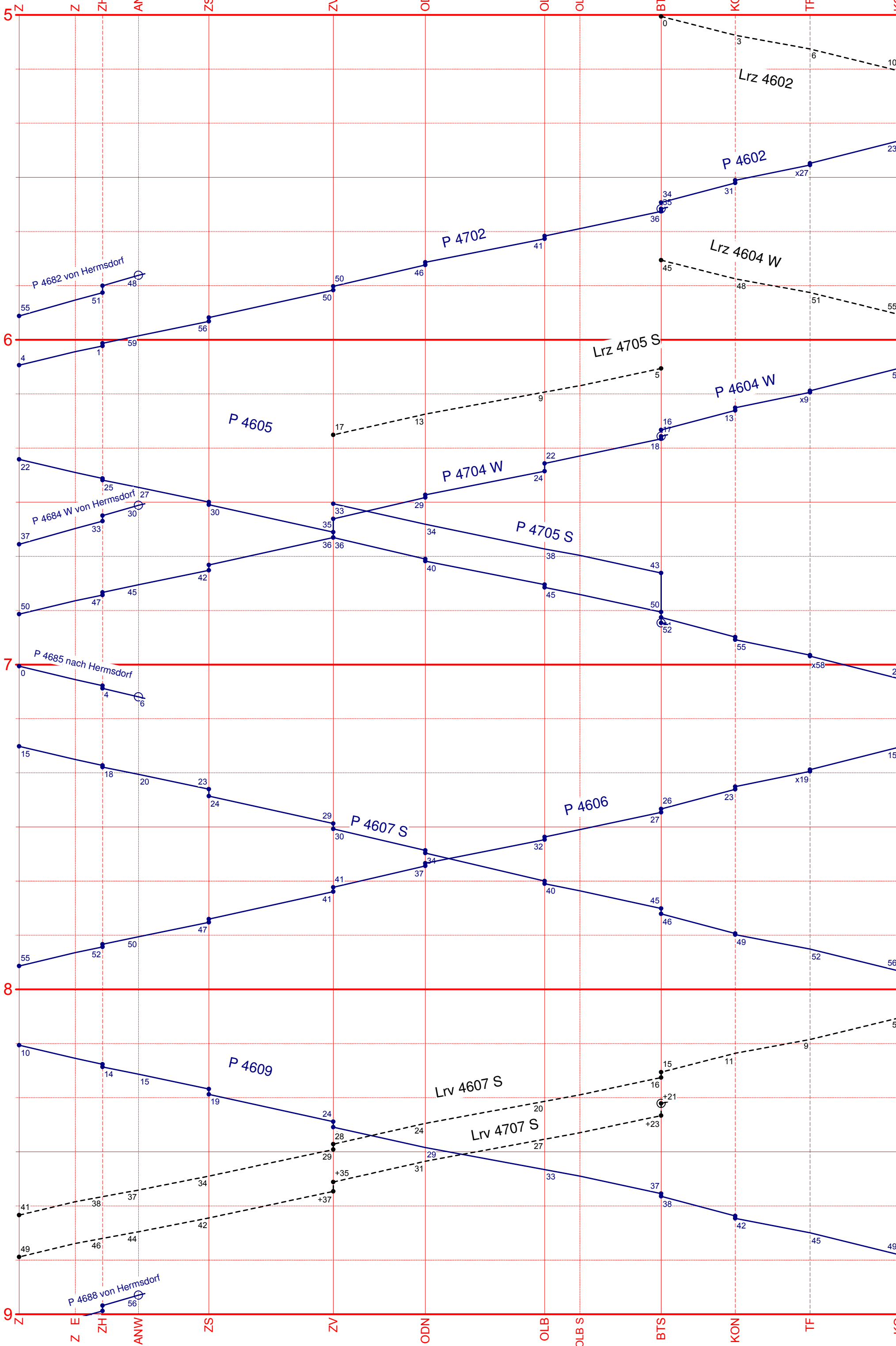
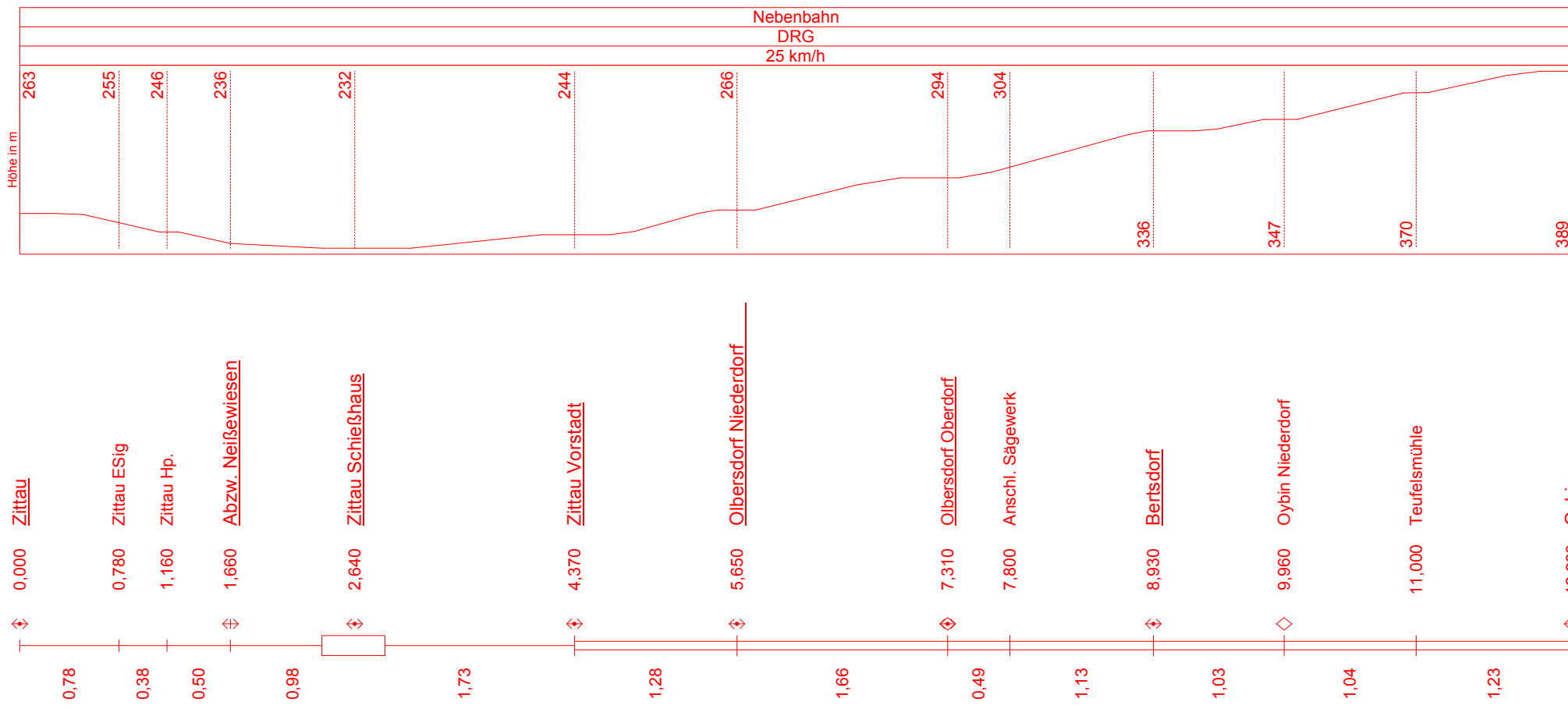

**Bertsdorf - Kurort Jonsdorf**  
- Schmalspurbahn 750 mm -

gültig vom 22.05.1932 bis 01.10.1932  
3,83 km

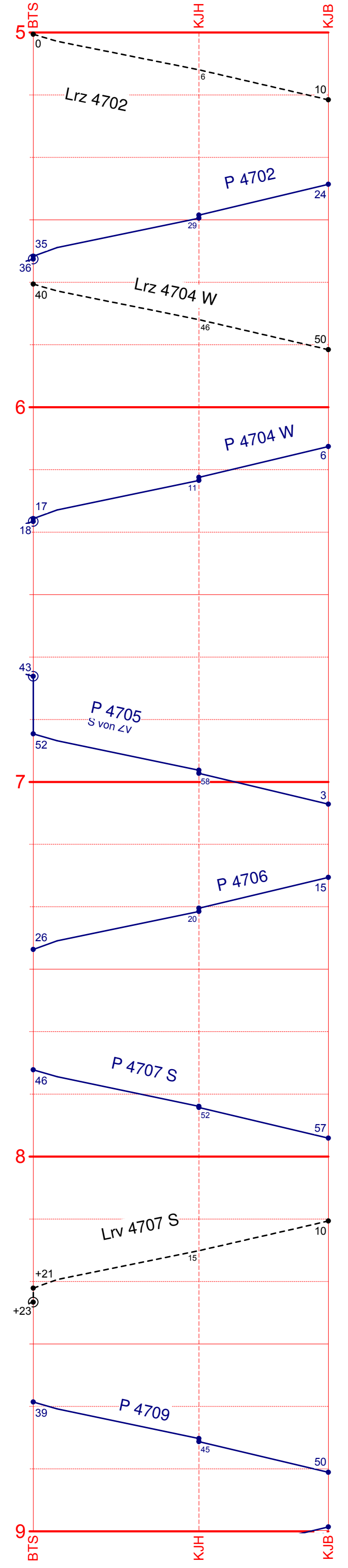
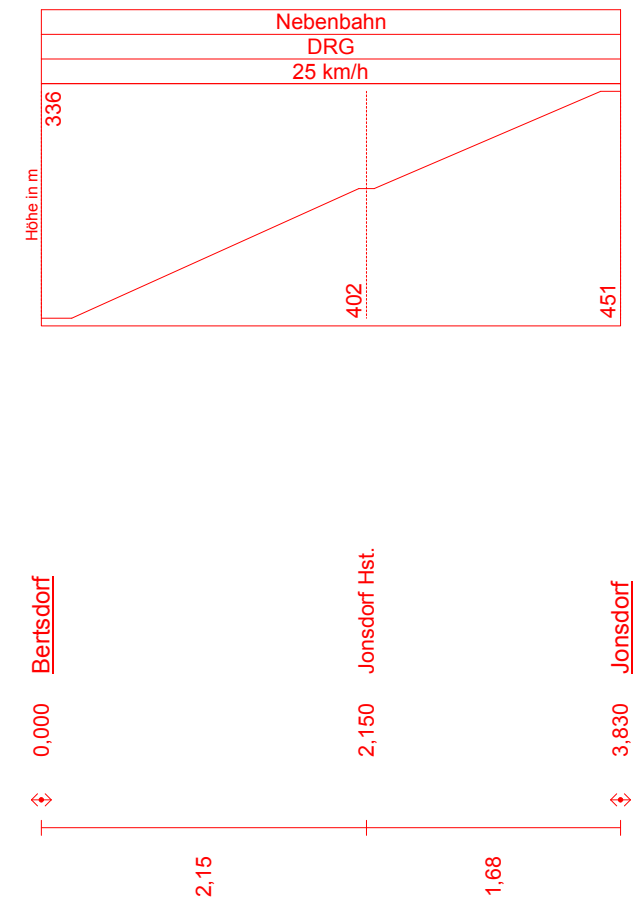

Zittau - Kurort Oybin  
- Schmalspurbahn 750 mm -

gültig vom 22.05.1932 bis 01.10.1932  
12,23 km

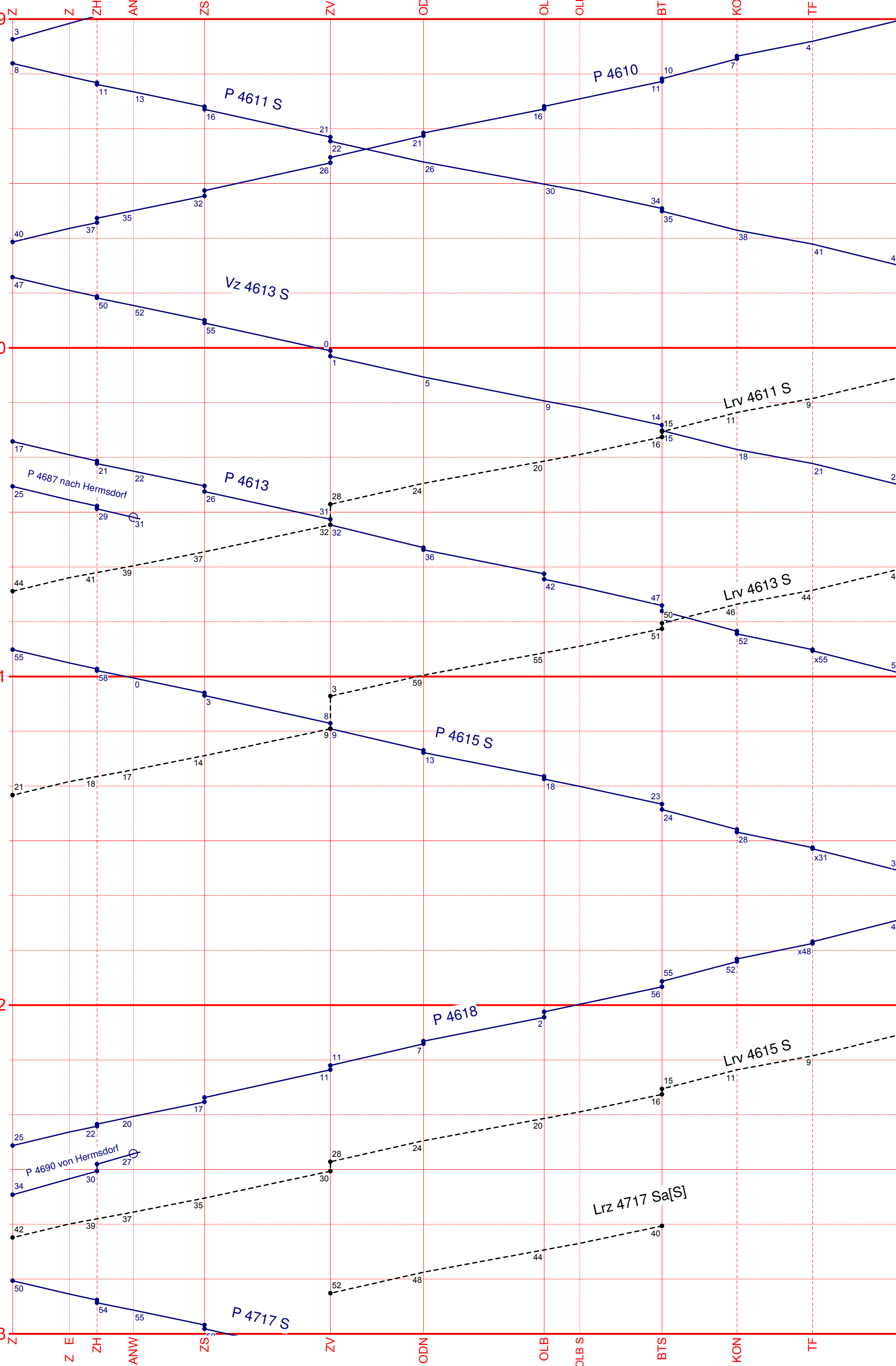
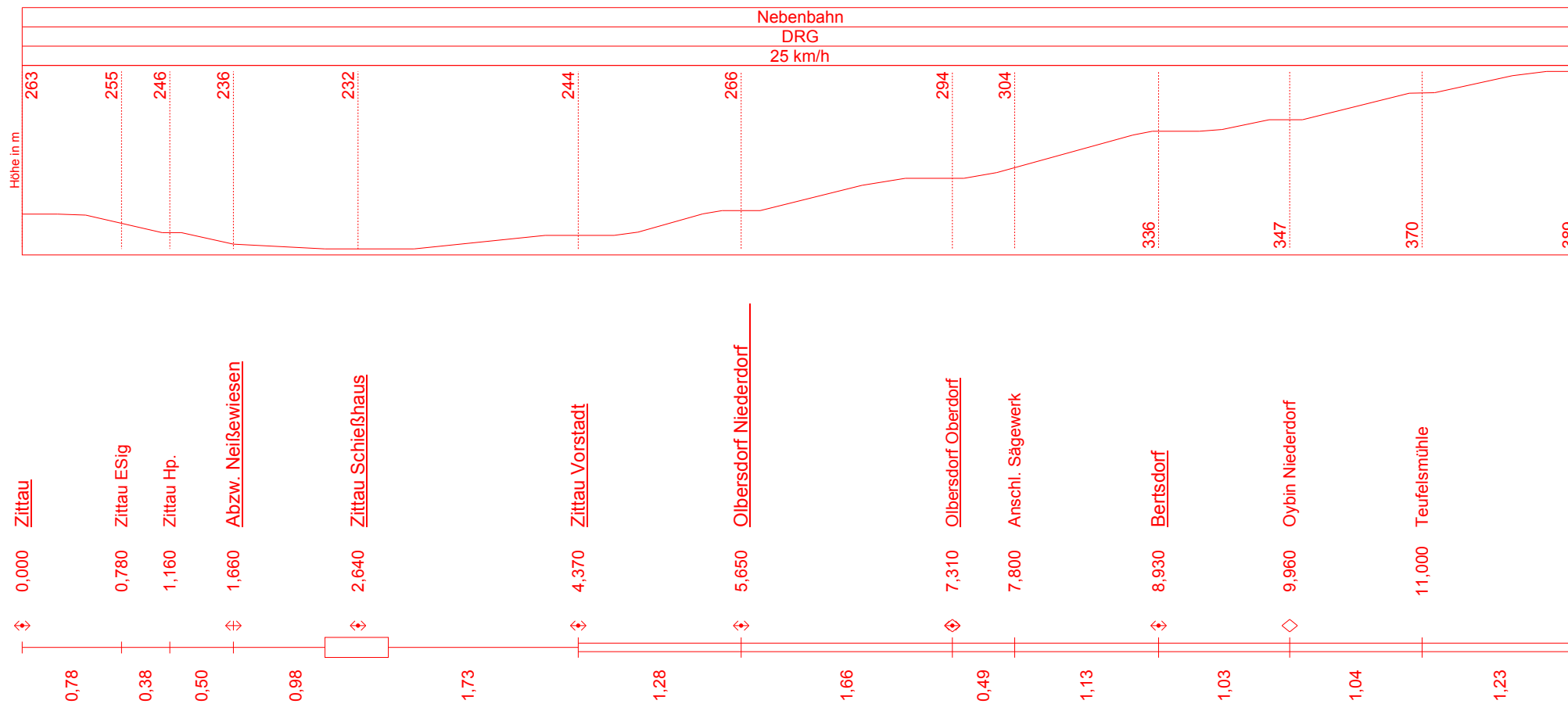

Bertsdorf - Kurort Jonsdorf  
- Schmalspurbahn 750 mm -

gültig vom 22.05.1932 bis 01.10.1932  
3,83 km

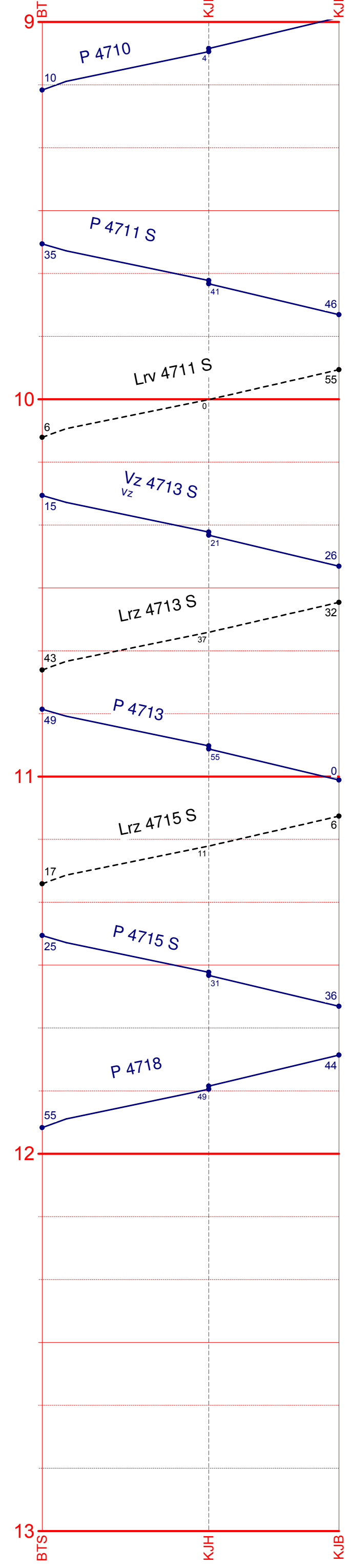
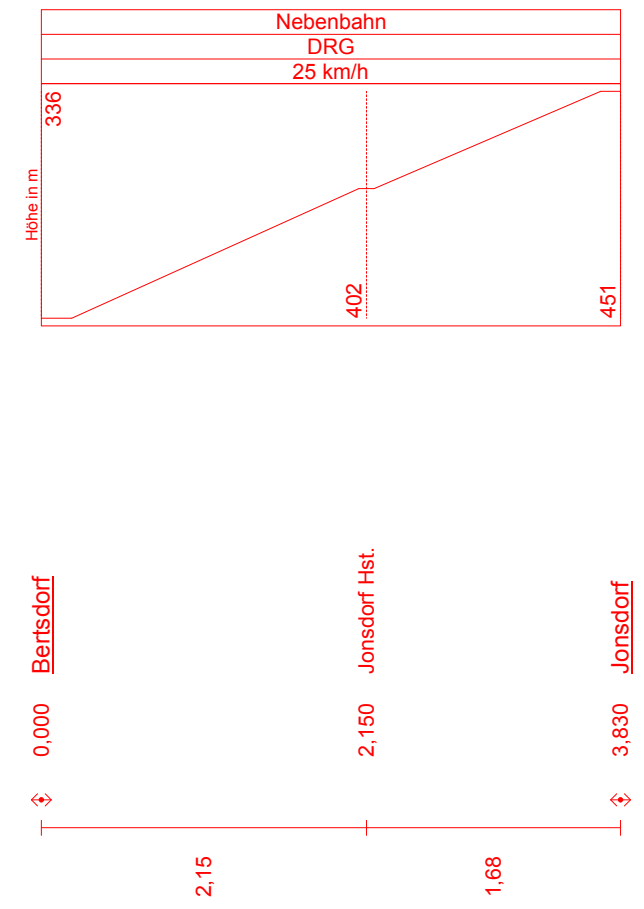

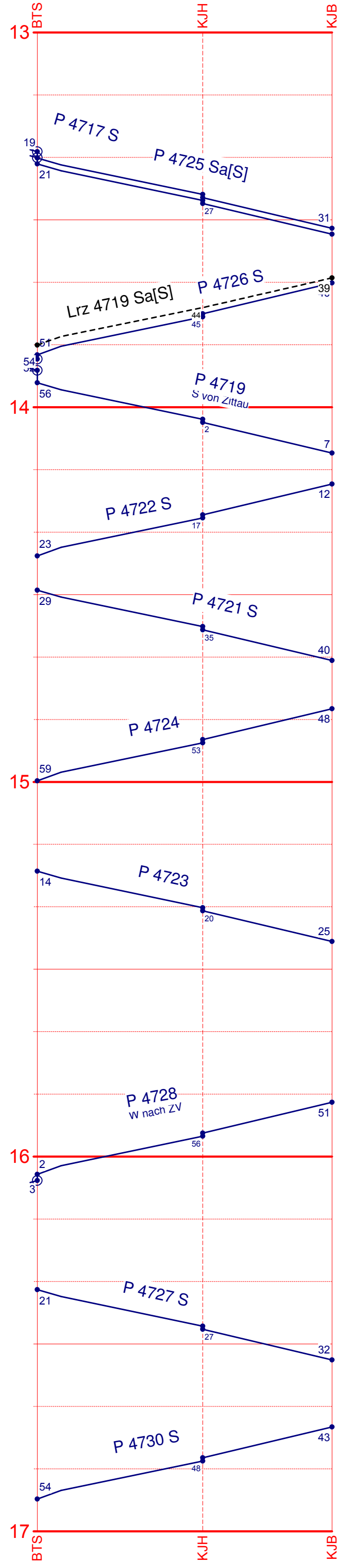
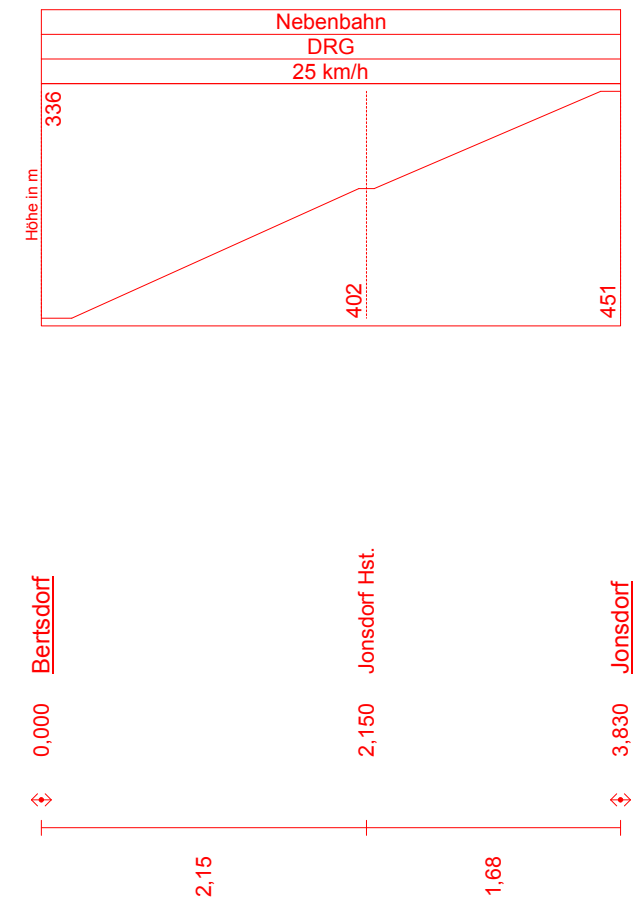
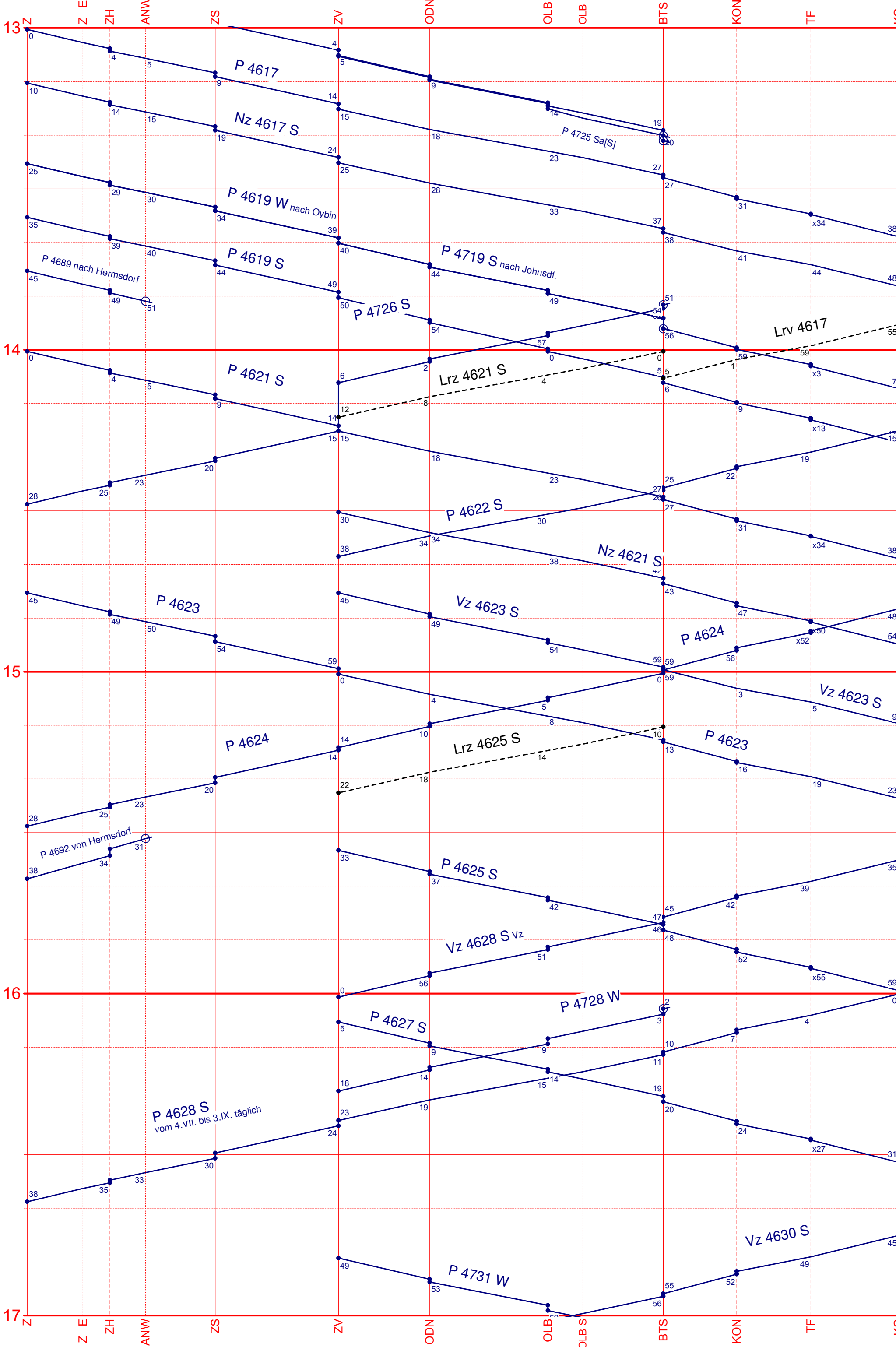
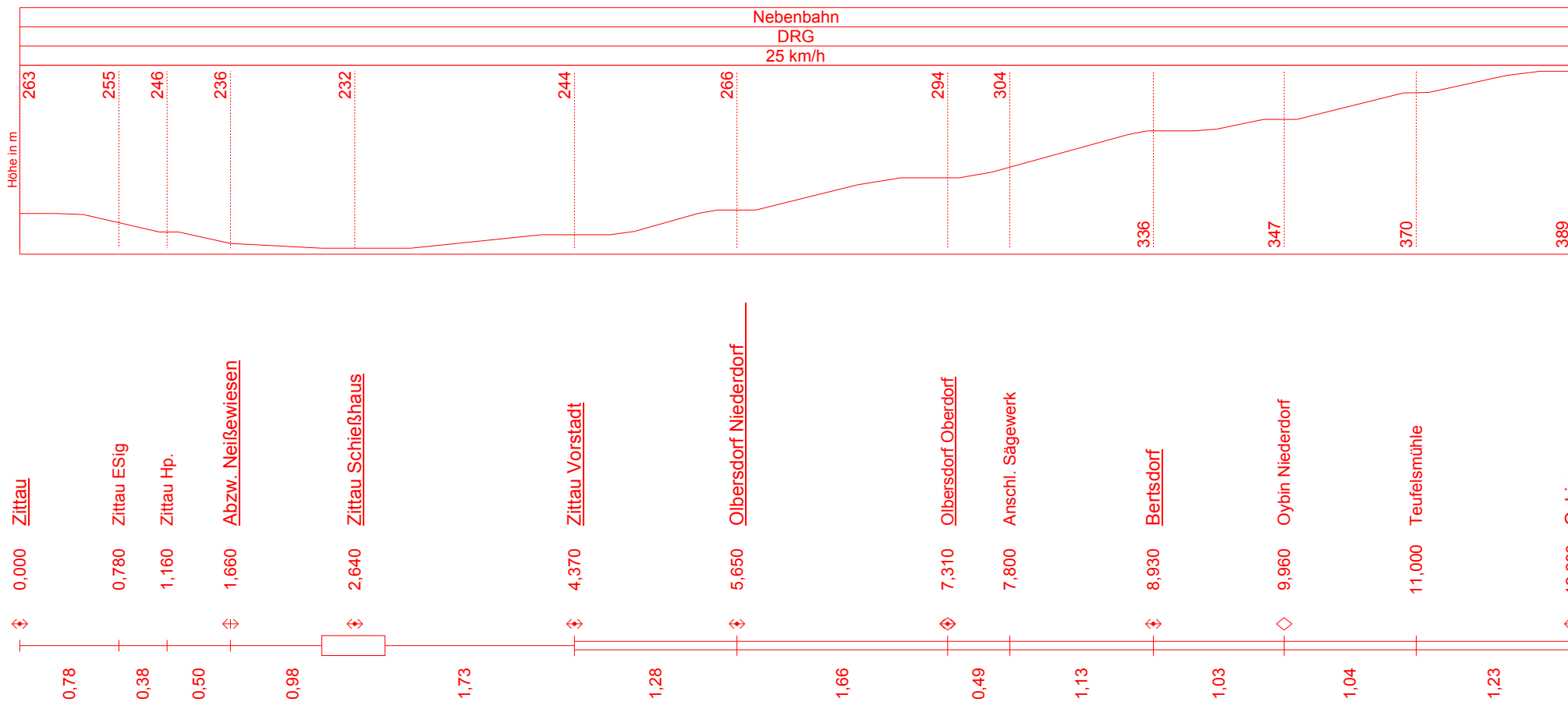



gültig vom 22.05.1932 bis 01.10.1932  
12,23 km

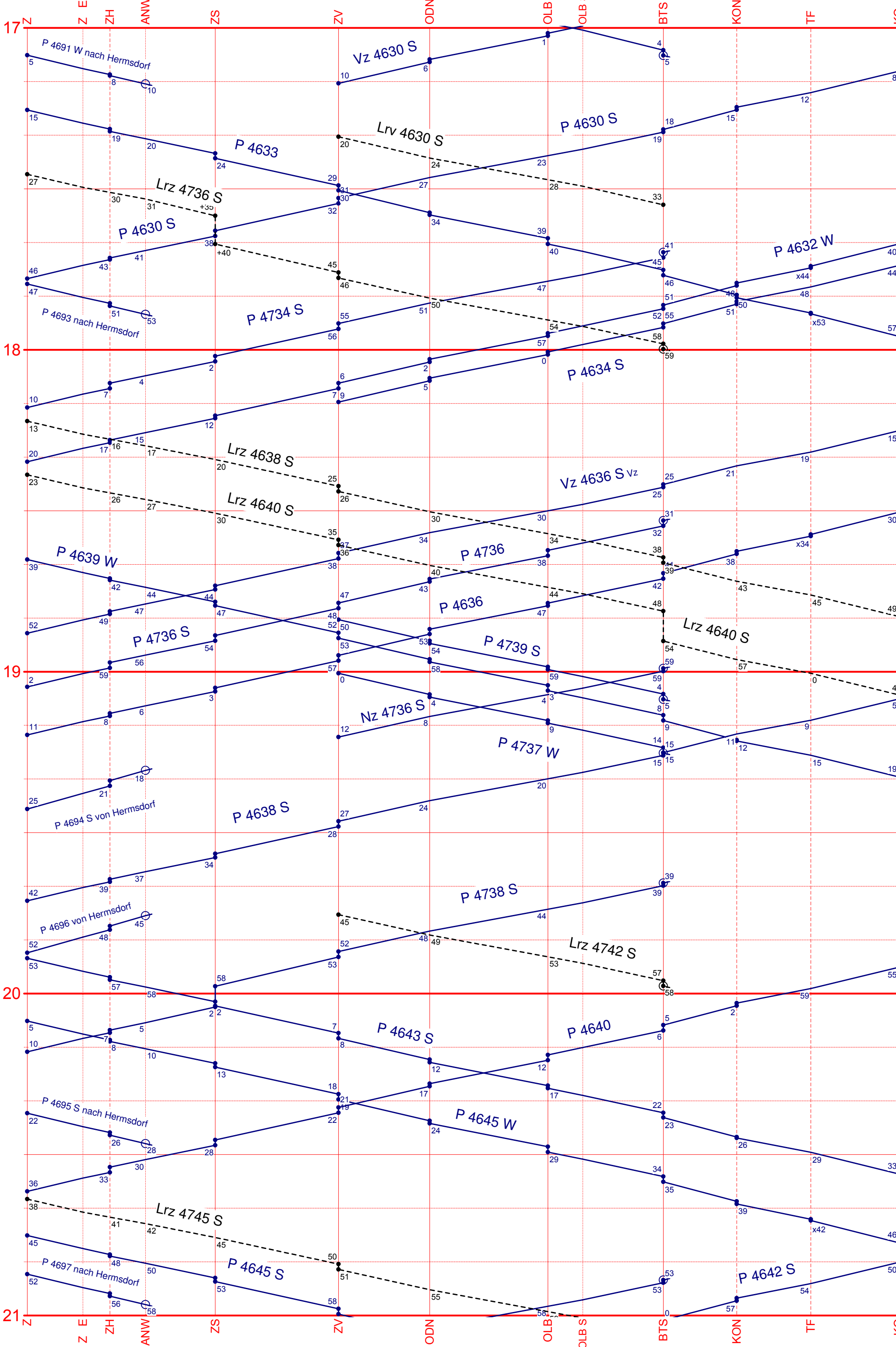
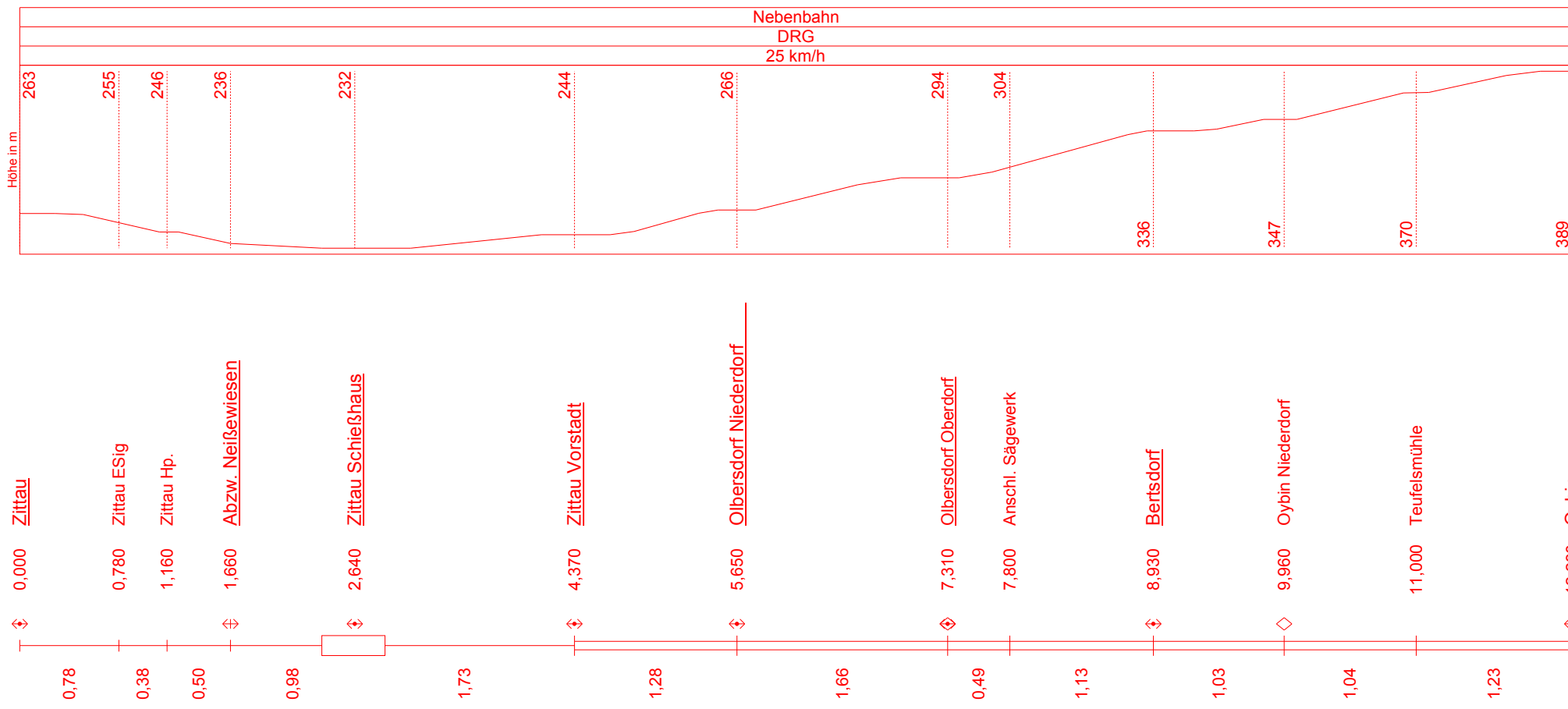

gültig vom 22.05.1932 bis 01.10.1932  
3,83 km

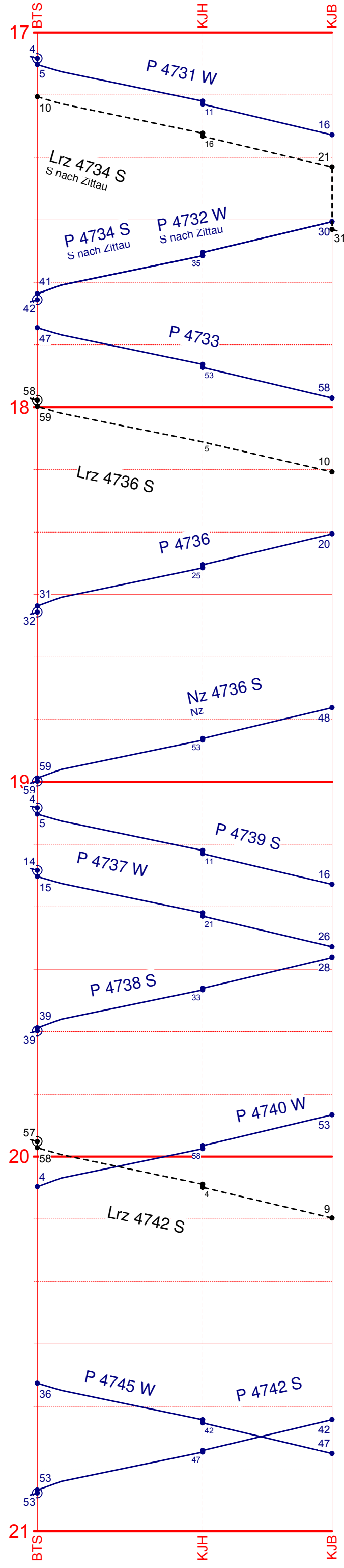
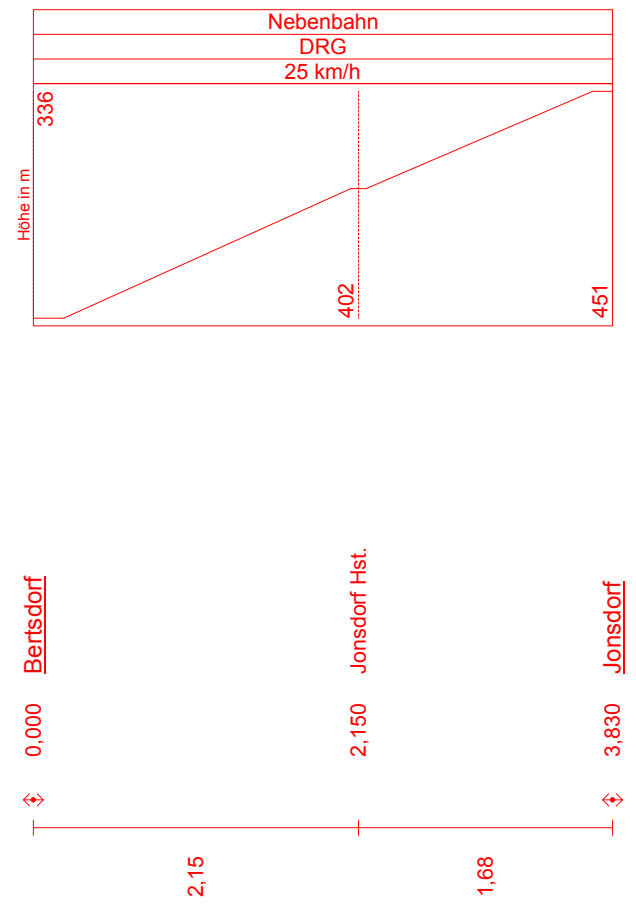

gültig vom 22.05.1932 bis 01.10.1932  
12,23 km

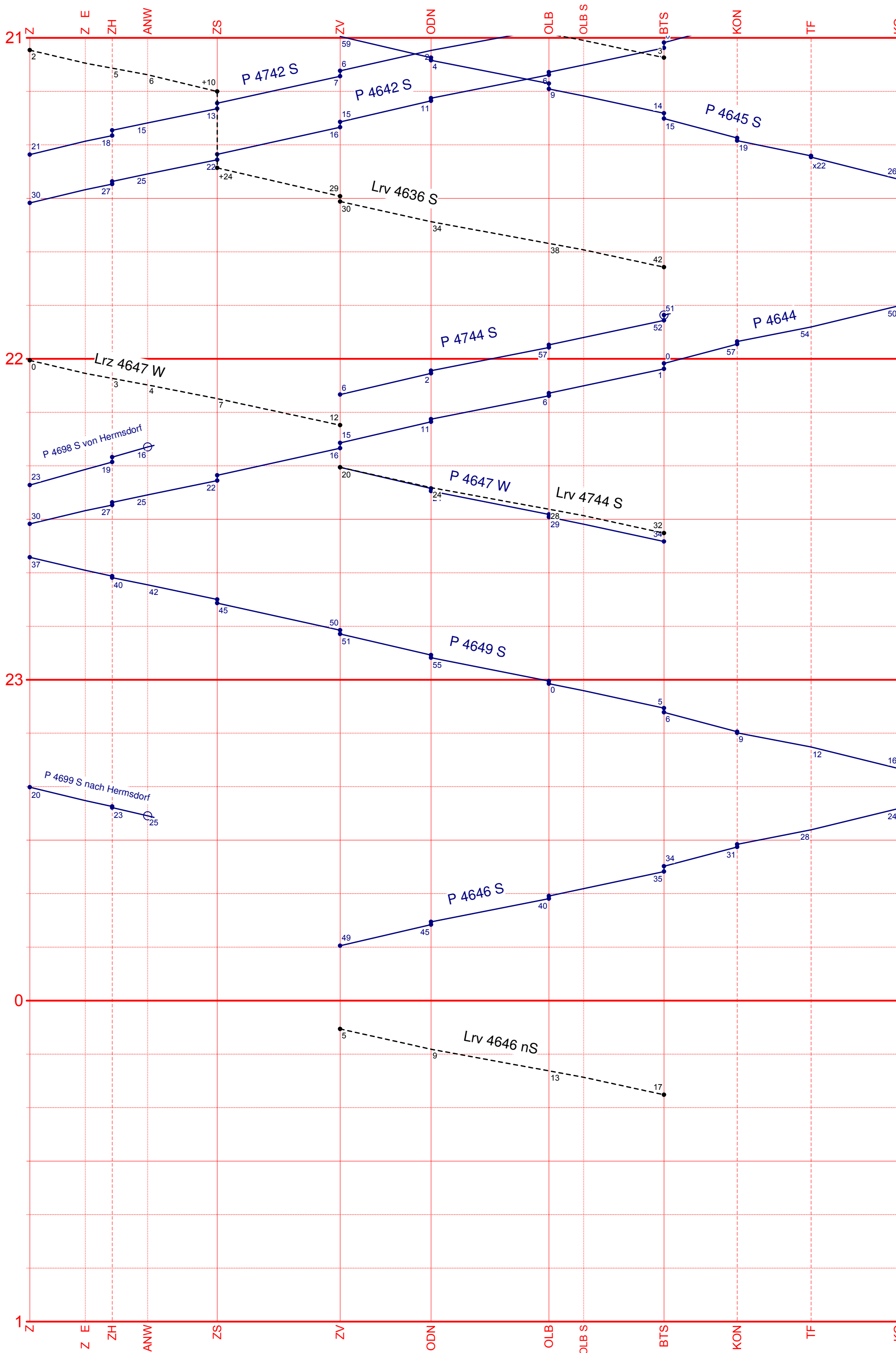
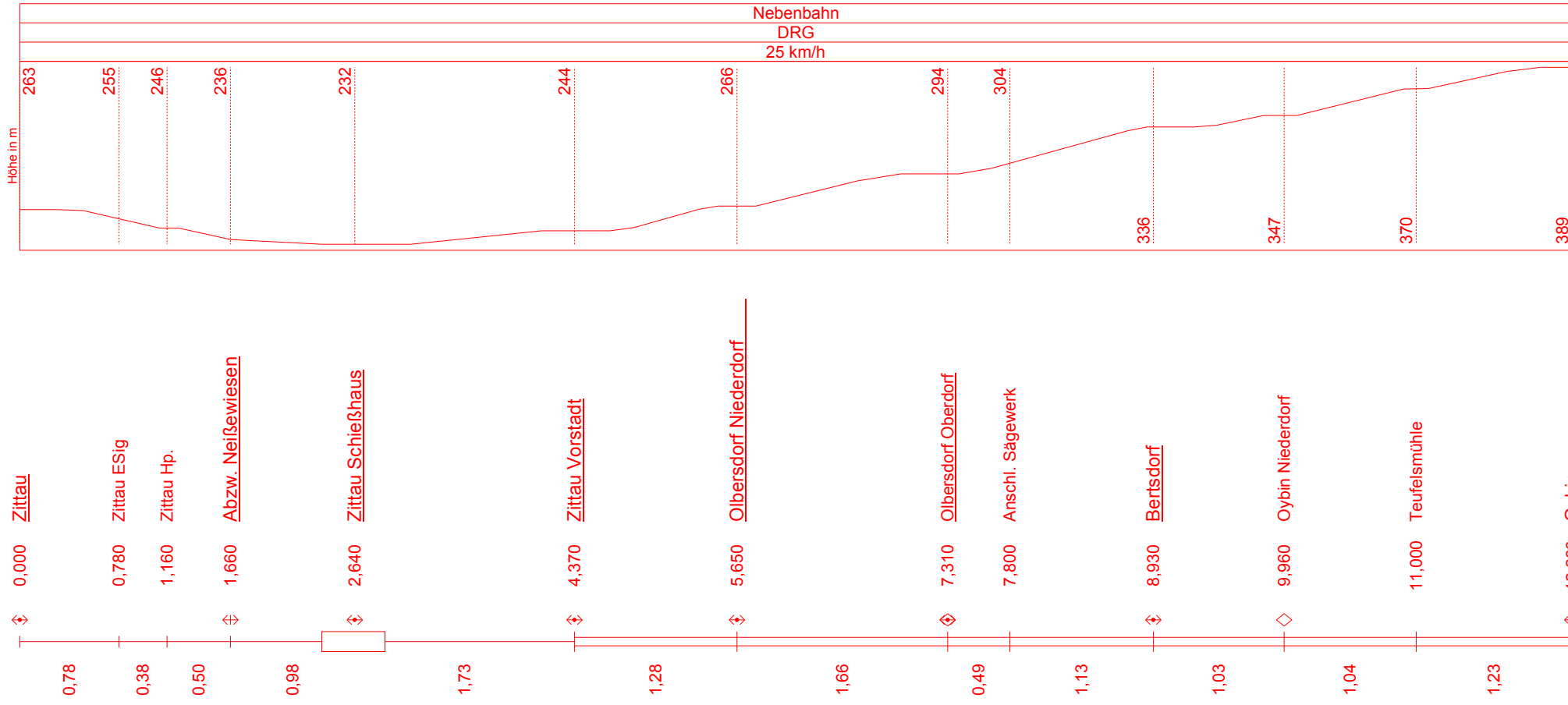

gültig vom 22.05.1932 bis 01.10.1932  
3,83 km

